

tielbürger

- Ⓚ Ersatzteilliste
- ⓕ Pièces détachées
- ⓐ Spare parts list
- Ⓛ Lista ricambi
- Ⓝ Deleliste

Copyright © 2002 by Julius Tielbürger GmbH & Co. KG, Stemwede Nachdruck, auch auszugsweise nicht gestattet. KR-361-107TS 04/2007-1

tk 620

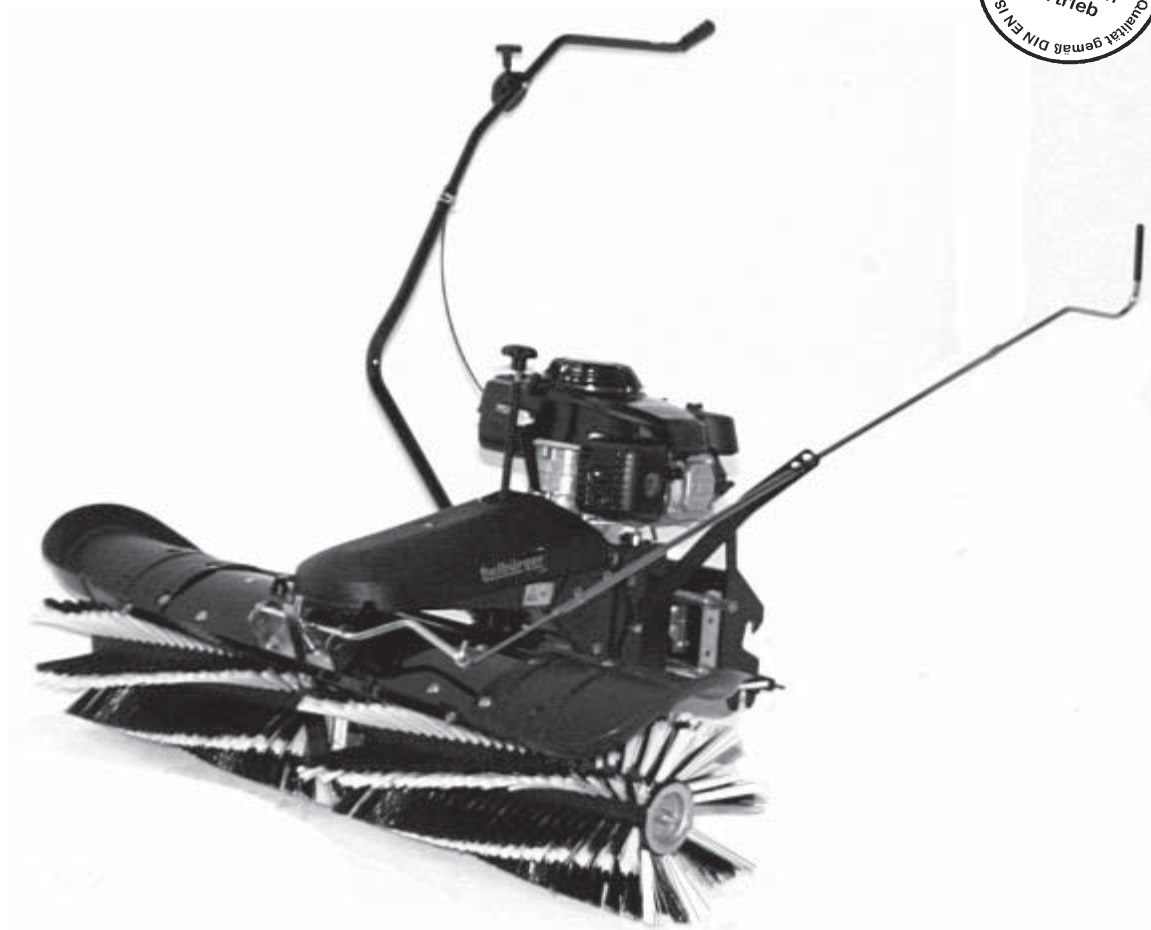

Julius Tielbürger GmbH & Co. KG Maschinenfabrik
Postdamm 12 D-32351 Stemwede-Oppenwehe Tel.: +49 (0) 57 73/80 20 Fax: +49 (0) 57 73/81 75
Internet: www.tielbuerger.de

Inhaltsverzeichnis

Parallelogramm	2
Parallélogramme	
Parallel lift unit	
Parallelogramma	
Kehrbürstensatz	4
Paire de brosses	
Pair of brushes	
Set spazzole	
Børste	
Bürstenabdeckung	6
Tôle de brosses	
Brushcover	
Coperchio spazzole	
Børstedeksel	
Stellsegment	8
Pièce de réglage	
Shifting segment	
Parte regolazione	
Stillestykke	
Bedienhebel	12
Levier de commande	
Activating lever	
Leva	
Hendel	

WICHTIG!

Die Spalte „Bemerkung“ hilft Ihnen, Teile zu identifizieren.

Verwenden Sie ausschließlich Originalersatzteile vom Hersteller. Dadurch wird die sichere Funktion des Gerätes gewährleistet.

Positionsnummern in Klammern sind Verschleißteile.

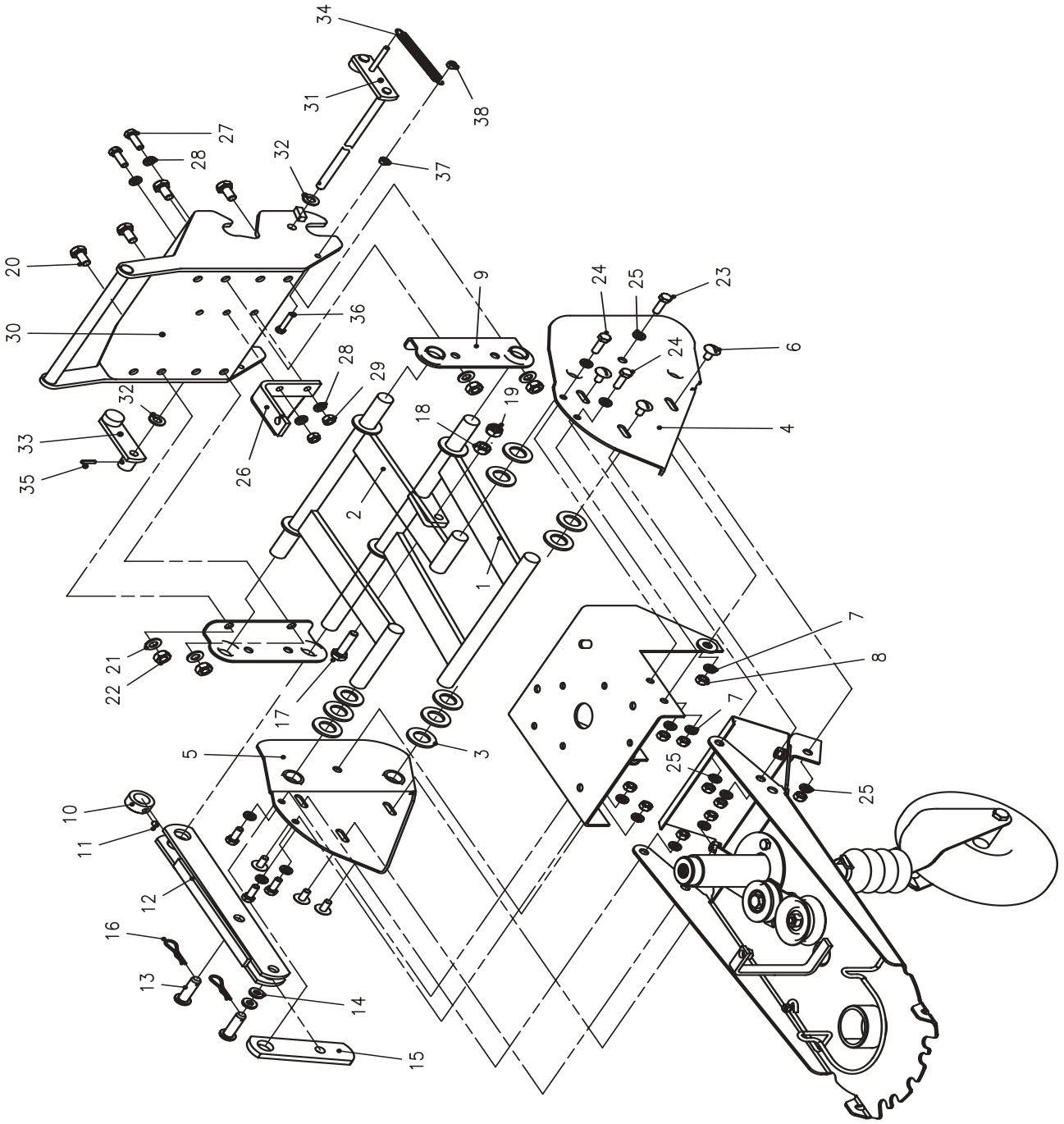



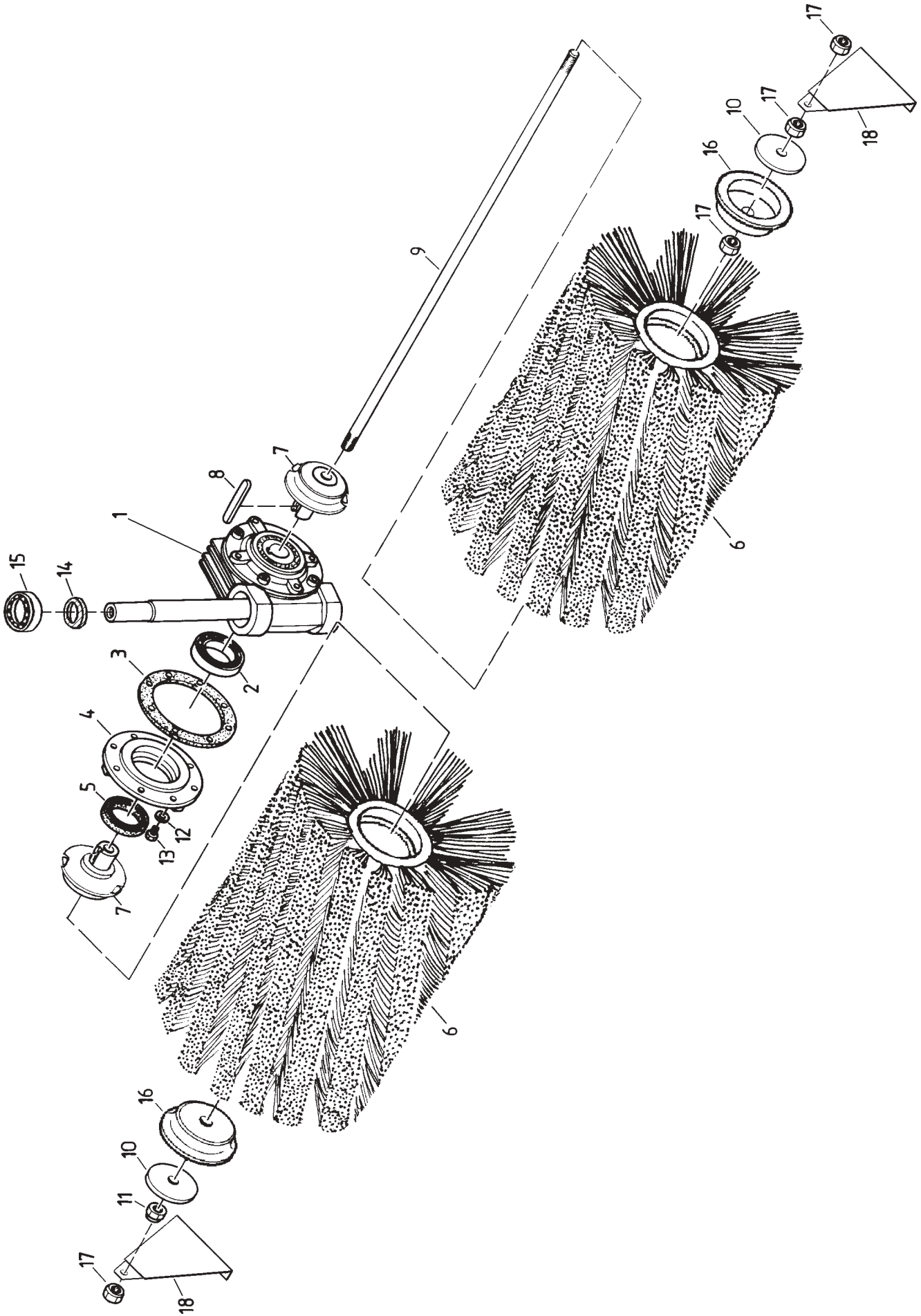

Pos.-Nr. Rep. Pos. Pos. Bilde-Nr.	Bestellnummer Référence Article number Nr. codice Bestillings-Nr.	Anzahl Qté. Quant. Q.tà Antall	Désignation	Description	Descrizione	Benevnelse	Bemerkung	
			(D)	(F)	(GB)	(I)	(N)	
1	AD-210-141z	1	Unterlenker Parallelogramm					
2	AD-210-140z	1	Oberlenker Parallelogramm					
3	HW-010-017z	10	ScheibeRondelle	Washer	Rondella	Skive	B 21	
4	DA-241-039-9005	1	Anschluss links					
5	DA-241-038-9005	1	Anschluss rechts					
6	HP-056-082z	6	Flachrundscharbe	Vis à tête bombée	Cut head bolt	Vite testa tonda	Flatrundskrue	M8x16
7	HW-050-007z	12	Scheibe	Rondelle	Washer	Rondella	Skive	Ø 8,4
8	HR-010-005z	12	Sechskantmutter	écrou à six pans	Hexagon nut	Dado esagonale	Sekskantmutter	M8
9	DA-241-037z	2	Lagerlasche	Tirant de roulement	Bearing tongue	Staffa cuscinetto	Lagerfeste	
10	KC-001-005z	1	Stellring	Tirant de roulement	Bearing tongue	Staffa cuscinetto	Lagerfeste	
11	HP-022-051z	1	Gewindestift	Cheville	Slotted set screw	Spina filettata	Gjengestift	
12	AD-210-142z	1	Doppellasche	Tirant double	Double tongue	Staffa doppia	Feste dobbel	
13	KC-001-076z	2	Splintbolzen	Boulon	Clevis pin	Bullone copiglia	Splintbolt	
14	HW-010-011z	2	Scheibe	Rondelle	Washer	Rondella	Skive	B 13
(15)	DB-590-009z	1	Lasche	Tirant	Tongue	Staffa	Feste	
16	KG-011-001z	2	Federstecker	Support de fiche	Hairpin clip	Spina elastica	Låsesplint	
17	HO-020-117z	1	Sechskantschraube	Vis à six pans	Hexagon bolt	Vite esagonale	Sekskantskrue	M10x40
18	HR-010-006z	1	Sechskantmutter	écrou à six pans	Hexagon nut	Dado esagonale	Sekskantmutter	M10
19	HR-030-006z	1	Sicherungsmutter	écrou de sûreté	Locknut	Dado autobloccante	Låsemutter	M10
20	HO-020-113z	4	Sechskantschraube	Vis à six pans	Hexagon bolt	Vite esagonale	Sekskantskrue	M10x20
21	HW-010-009z	8	Scheibe	Rondelle	Washer	Rondella	Skive	B 10,5
22	HR-010-006z	4	Sechskantmutter	écrou à six pans	Hexagon nut	Dado esagonale	Sekskantmutter	M10
23	HO-020-084z	2	Sechskantschraube	Vis à six pans	Hexagon bolt	Vite esagonale	Sekskantskrue	M8x25
24	HO-020-083z	4	Sechskantschraube	Vis à six pans	Hexagon bolt	Vite esagonale	Sekskantskrue	M8x20
25	HW-050-007z	6	Scheibe	Rondelle	Washer	Rondella	Skive	Ø 8,4
26	AD-210-149-9005	1	Bowdenzugstütze	Support	Bracket	Supporto	Støtte	
27	HO-020-083z	2	Sechskantschraube	Vis à six pans	Hexagon bolt	Vite esagonale	Sekskantskrue	M8 x 20
28	HW-050-005z	4	Scheibe	Rondelle	Washer	Rondella	Skive	Ø 8,4
29	HR-010-005z	2	Sechskantmutter	écrou à six pans	Hexagon nut	Dado esagonale	Sekskantmutter	M8
30	AE-100-140-9005	1	Halter	Support	Stud oder bracket (Flach)	Supporto	Holder	
31	AE-100-142-9004	1	Sperre	Barrière	Arrestor	Bloccaggio	Lås	
32	HW-010-009z	2	Scheibe	Rondelle	Washer	Rondella	Skive	B10,5
33	AE-100-141-9003	1	Hebel	Levier	Lever	Leva	Hendel	
(34)	HI-010-010z	1	Zugfeder	Ressort de traction	Extension spring	Molla di trazione	Fjær	
35	HX-010-140	1	Spannstift	Ressort de traction	Extension spring	Molla di trazione	Fjær	Ø4x20
36	HO-020-057z	1	Sechskantschraube	Vis à six pans	Hexagon bolt	Vite esagonale	Sekskantskrue	M6x30
37	HR-010-004z	1	Sechskantmutter	écrou à six pans	Hexagon nut	Dado esagonale	Sekskantmutter	M6
38	HR-030-004z	1	Sechskantmutter	écrou à six pans	Hexagon nut	Dado esagonale	Sekskantmutter	M6

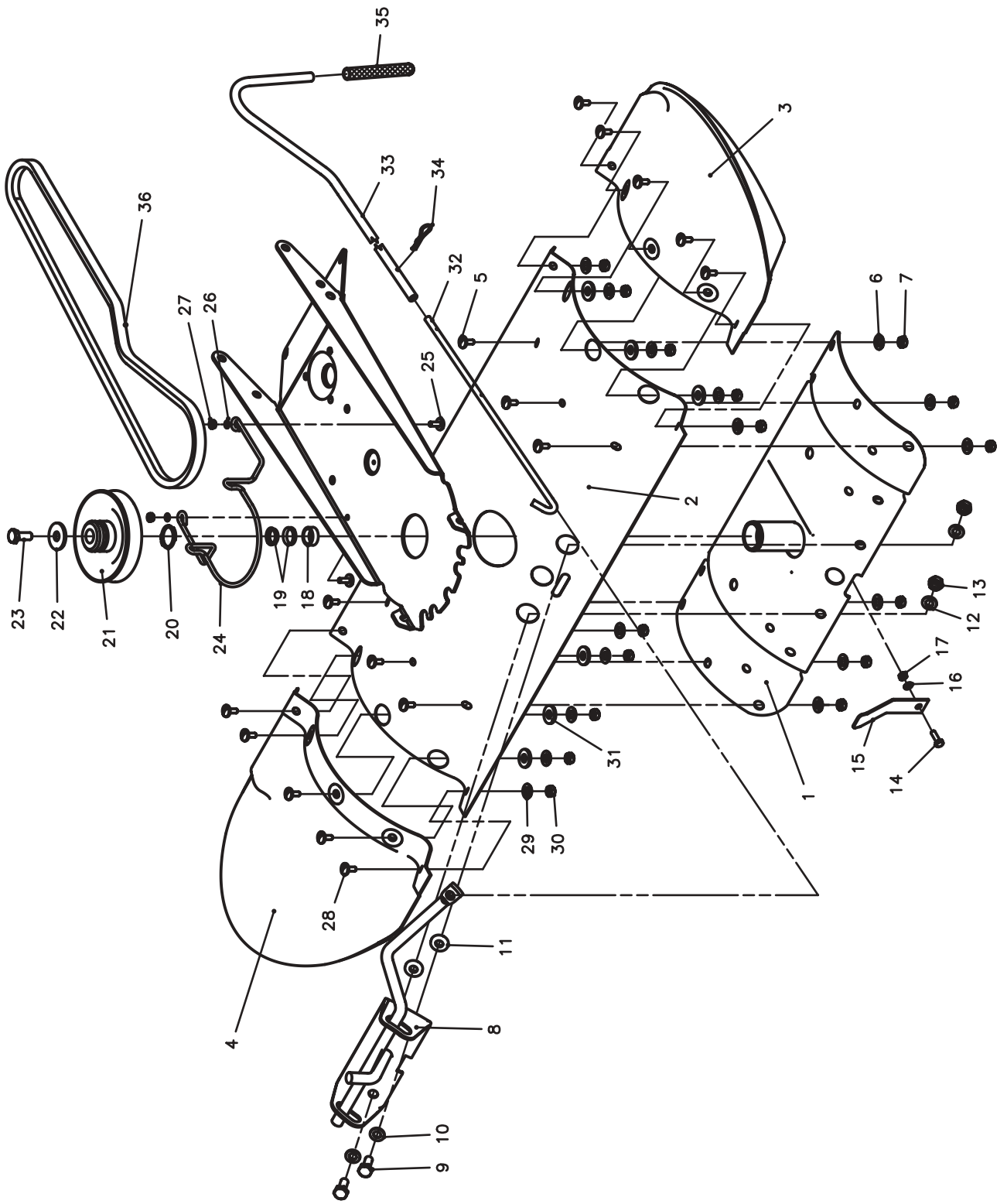

Pos.-Nr. Rep. Pos. Bilde-Nr.	Bestellnummer Référence Article number Nr. codice Bestillings-Nr.	Anzahl Qté. Quant. Q.tà Antall	Désignation	Description	Descrizione	Benevnelse	Bemerkung	
			(D)	(F)	(GB)	(I)	(N)	
(1)	AZ-016-019	1	Schneckengetriebe, kpl.	Boîte de vitesses, cpl.	Gear drive, cpl.	Trasmissione, cpl.	Gear, kpl.	
(2)	HA-010-061	2	Kugellager	Roulement à billes	Ball bearing	Cuscinetto a sfere	Kulelager	
(3)	HL-002-030	2	Dichtung	Joint	Sealing	Guarnizione	Pakning	
4	KC-001-063	2	Flansch	Flasque	Flange	Flangia	Flens	
5	HL-001-040	2	Wellendichtring	Bague	Ring	Anello	Ring	
(6)	AD-090-140	1	Kehrbürstensatz	Paire des brosses	Pair of brushes	Set spazzole	Børste Universal	
7	AD-330-142-9005	2	Mitnehmer	Entraîneur	Drive pin	Trascinatore	Medbringer	
8	KH-010-013	1	Paßfeder	Ressort	Parallel key	Linguetta	Kile	
9	DC-100-098z	1	Achse	Arbre	Axle	Ase	Aksel	
10	DA-332-007-9005	2	Scheibe	Rondelle	Washer	Rondella	Skive	
11	HR-030-007z	1	Sicherungsmutter	Ecrou de sûreté	Locknut	Dado autobloccane	Låsemutter	M 12
12	HW-010-004z	6	Scheibe	Rondelle	Washer	Rondella	Skive	B 6,4
13	HO-020-053z	6	Sechskantschraube	Vis à six pans	Bolt	Vite esagonale	Sekskantskrue	M 6 x 12
14	HK-002-007	1	O-Ring	Bague	O-ring	O-ring	O-ring	
(15)	HA-030-005	1	Kugellager	Roulement à billes	Ball bearing	Cuscinetto a sfere	Kulelager	
16	DA-241-024-9005	2	Kappe	Couvercle	Cap	Coperchietto	Kapp	
17	HR-010-007z	4	Sechskantmutter	Ecrou à six pans	Hexagon nut	Dado esagonale	Sekskantmutter	M 12
18	DA-180-204z	2	Stütze	Support	Bracket	Supporto	Støtte	





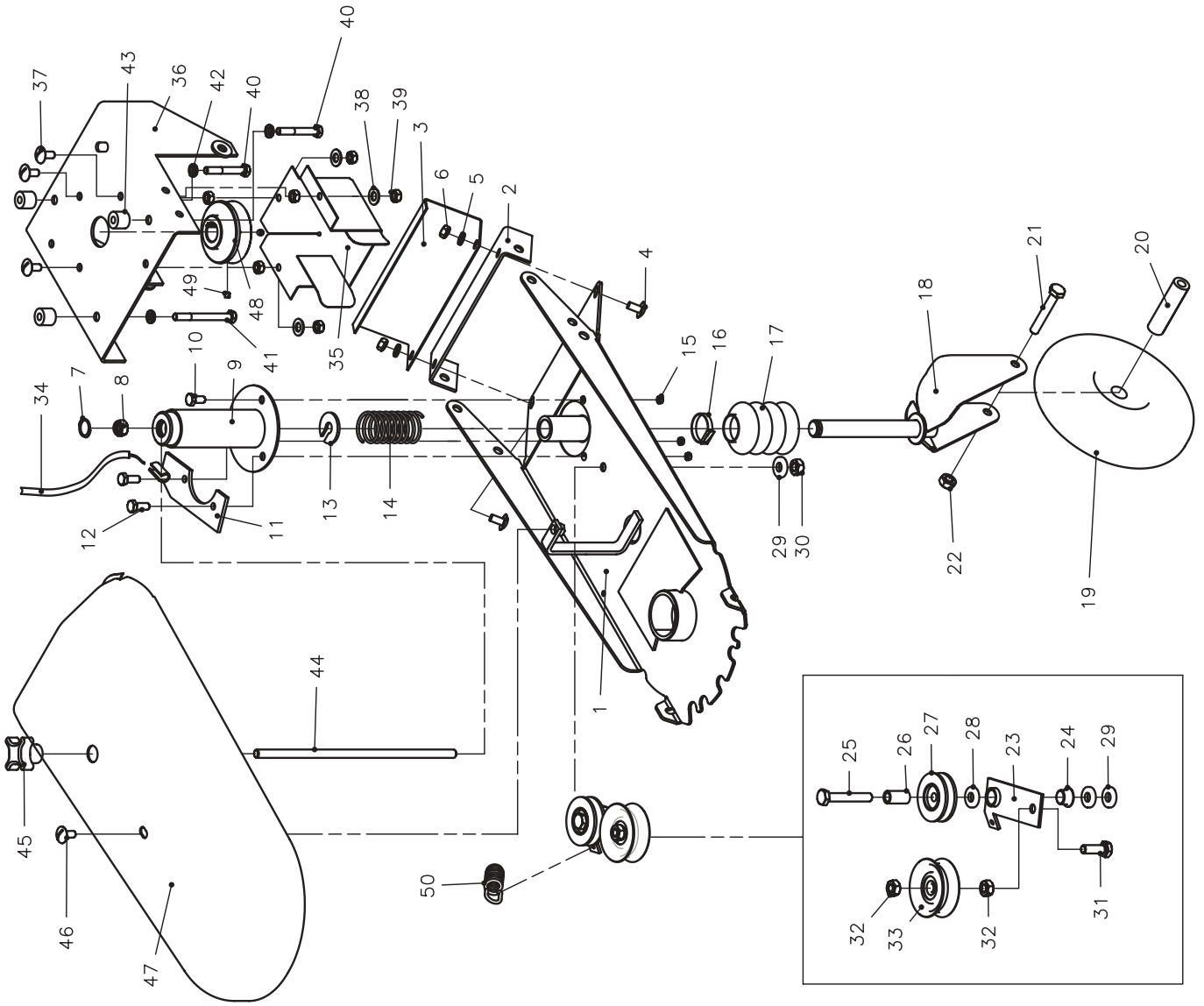



Pos.-Nr. Rep. Pos. Pos. Bilde-Nr.	Bestellnummer Référence Article number Nr. codice Bestillings-Nr.	Anzahl Qté. Quant. Q.tà Antall		Désignation 	Description 	Descrizione 	Benevnelse 	Bemerkung	
1	AD-310-147-3000	1		Getriebehalter	Support d'entraînement	Gear stud	Supporto trasmissione	Gearholder	
(2)	HJ-010-133-9005	1		Bürstenabdeckung, Mittelteil	Tôle de brosses, (milieu)	Brushcover, (middle)	Coperchio spazzole, (mezzo)	Børstedeksel,	
(3)	HJ-010-141-9005	1		Bürstenabdeckung, links	Tôle de brosses, gauche	Brushcover, left	Coperchio spazzole, sx sinistro (a)	Børstedeksel, venstre	
(4)	HJ-010-142-9005	1		Bürstenabdeckung, rechts	Tôle de brosses, droite	Brushcover, right	Coperchio spazzole, dx destro (a)	Børstedeksel, høyre	
5	HP-056-082z	6		Flachrundschraube	Vis à tête bombée	Cut head bolt	Vite testa tonda	Flatrundskruue	M 8X16
6	HW-010-007z	6		Scheibe	Rondelle	Washer	Rondella	Skive	B 8,4
7	HR-010-005z	6		Sechskantmutter	écrou à six pans	Hexagon nut	Dado esagonale	Sekskantmutter	M 8
8	AD-200-149z	1		Schwenkeinheit	Pièce de tourner	Selecting piece	Parte orientamento		
9	HO-020-114z	2		Sechskantschraube	Vis à six pans	Hexagon bolt	Vite esagonale	Sekskantskrue	M 10
10	HW-010-009z	2		Scheibe	Rondelle	Washer	Rondella	Skive	B 10,5
11	HW-050-009z	2		Scheibe	Rondelle	Washer	Rondella	Skive	Ø 10,5
12	HW-010-009z	2		Scheibe	Rondelle	Washer	Rondella	Skive	B 10,5
13	HR-010-006z	2		Sechskantmutter	écrou à six pans	Hexagon nut	Dado esagonale	Sekskantmutter	M 10
14	HO-020-055z	1		Sechskantschraube	Vis à six pans	Hexagon bolt	Vite esagonale	Sekskantskrue	M 6x20
(15)	HI-030-009z	1		Blattfeder	Lame ressort	Blade spring	Molla a balestra	Bladefjær	
16	HW-030-005z	2		Scheibe	Rondelle	Washer	Rondella	Skive	R 6,6
17	HR-010-004z	1		Sechskantmutter	écrou à six pans	Hexagon nut	Dado esagonale	Sekskantmutter	M 6
18	DC-241-015	1		Abstandshülse	Douille d'écartement	Spacer tube	Boccola distanziale	Avstandshylse	
(19)	KC-001-039	1		Spannelement-Satz	Pièce de serrage	Tensioning piece	Parte tenditore	Spennstykke	
20	HU-010-048	1		Sicherungsring	Anneau d'arrêt	Retaining ring	Seger	Semering	A 48
(21)	AZ-001-366-9005	1		Keilriemenscheibe	Poulie	V-belt pulley	Puleggia	Kileremskive	
22	HW-060-009z	1		Scheibe	Rondelle	Washer	Rondella	Skive	A 10,5
23	HO-020-114z	1		Sechskantschraube	Vis à six pans	Hexagon bolt	Vite esagonale	Sekskantskrue	M 10x25
(24)	HI-040-023z	1		Keilriemenführung	Guidage de courroie	V-belt guide	Guida cinghia	Kileremsføring	
25	HP-056-054z	2		Flachrundschraube	Vis à tête bombée	Cut head bolt	Vite testa tonda	Flatrundskruue	M 6x16
26	HW-010-004z	2		Scheibe	Rondelle	Washer	Rondella	Skive	B 6,4
27	HR-010-004z	2		Sechskantmutter	écrou à six pans	Hexagon nut	Dado esagonale	Sekskantmutter	M 6
28	HP-056-082z	10		Sechskantschraube	Vis à six pans	Hexagon bolt	Vite esagonale	Sekskantskrue	M 8X16
29	HW-010-007z	10		Scheibe	Rondelle	Washer	Rondella	Skive	
30	HR-010-005z	10		Sechskantmutter	écrou à six pans	Hexagon nut	Dado esagonale	Sekskantmutter	M 8
31	Hw-060-011z	6		Scheibe	Rondelle	Washer	Rondella	Skive	
32	DC-060-057z	1		Haken	Crochet	Hook	Gancio	Krok	
33	DM-030-001z	1		Bedienstange	Levier de commande	Activating lever	Leva	Hendel	
34	KG-011-001z	1		Federstecker	Support de fiche	Hairpin clip	Spina elastica	Låsesplint	
(35)	HJ-010-102	1		PVC Handgriff	Poignée	Handle	Leva	Handtak	
(36)	HB-020-191	1		Spezialkeilriemen	Courroie spéciale	Special V-belt	Cinghia speciale	Kilerem spesial	

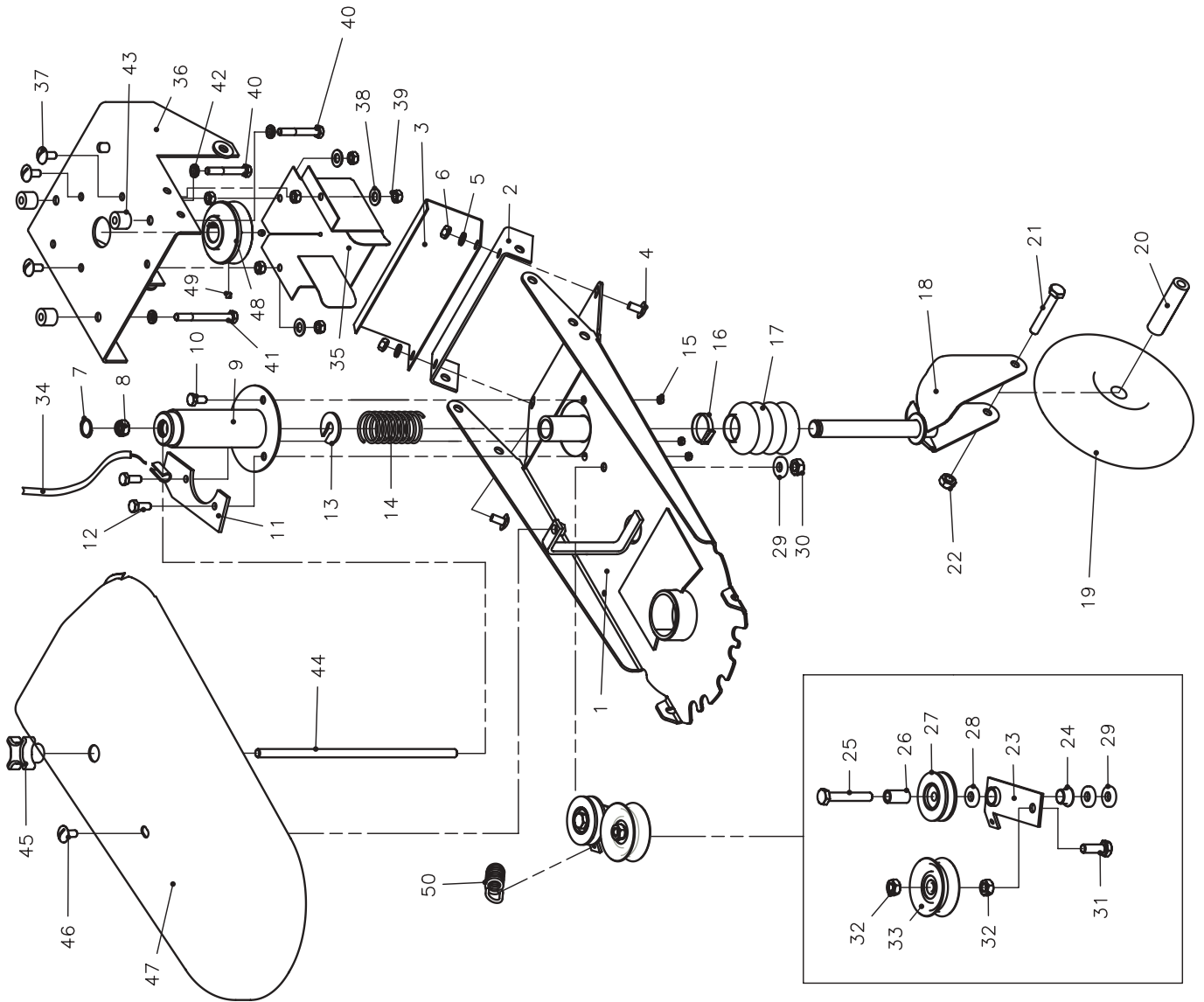





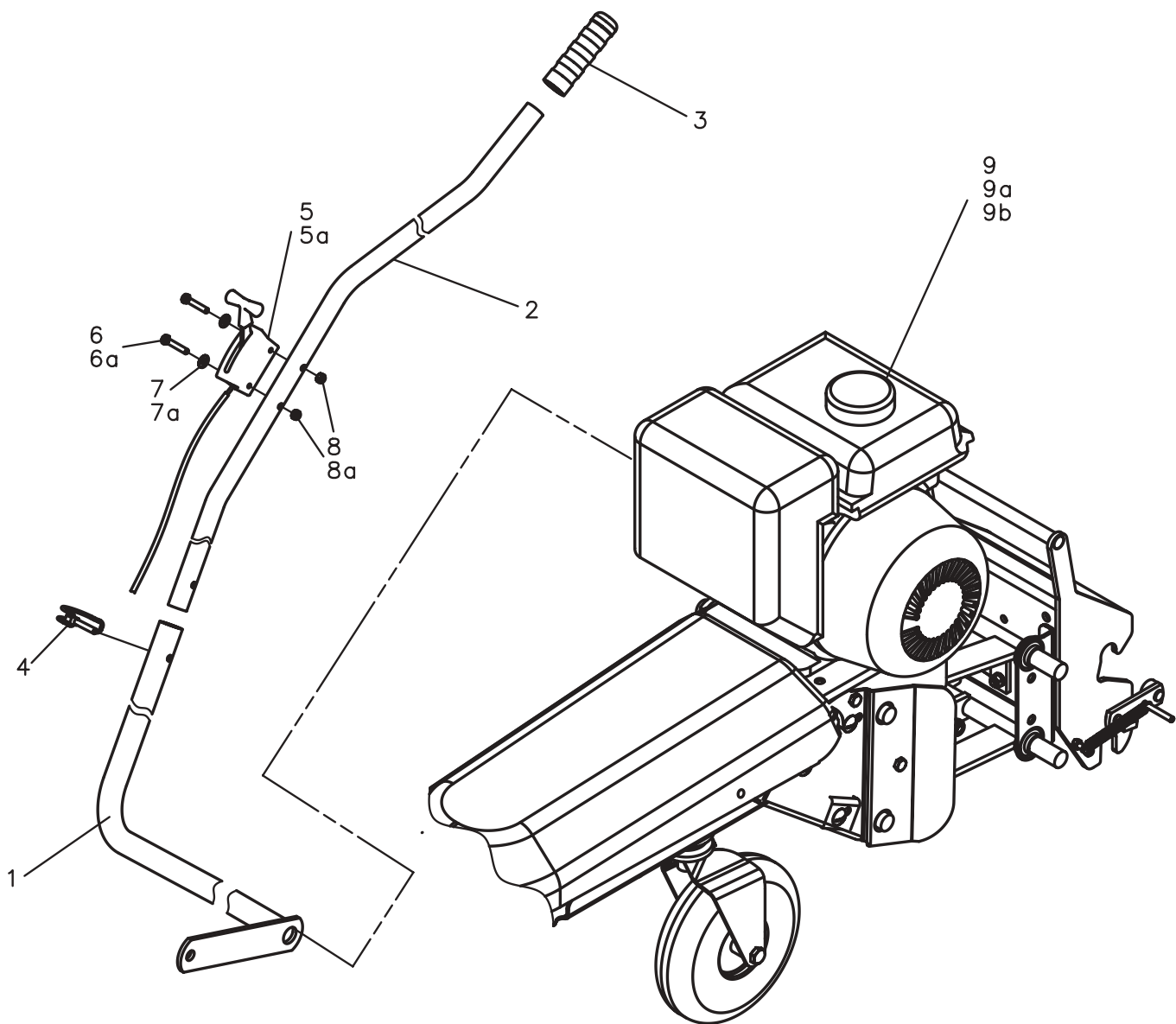

Pos.-Nr. Rep. Pos. Pos. Bilde-Nr.	Bestellnummer Référence Article number Nr. codice Bestillings-Nr.	Anzahl Qté. Quant. Q.tà Antall		Désignation 	Description 	Descrizione 	Benevnelse 	Bemerkung	
(1)	AD-210-146-9005	1		Stellsegment	Pièce de réglage	Shifting segment	Parte regolazione	Stillestykke	
2	DA-240-327-9005	1		Halter	Support	Stud oder bracket (Flach)	Supporto	Holder	
3	DA-180-247-9005	1		Eingriffschutz	Protecteur	Protector	Protezione	Deksel	
4	HP-056-083z	2		Flachrundschraube	Vis à tête bombée	Cut head bolt	Vite testa tonda	Flatrundskruue	M8x20
5	HW-050-007z	2		Scheibe	Rondelle	Washer	Rondella	Skive	B8,4
6	HR-010-005z	2		Sechskantmutter	écrou à six pans	Hexagon nut	Dado esagonale	Sekskantmutter	M8x16
7	HU-020-020	1		Sicherungsring	Anneau d'arrêt	Retaining ring	Seger	Semering	A20
8	HR-030-006z	1		Sicherungsmutter	écrou de sûreté	Locknut	Dado autobloccante	Låsemutter	M10
9	AD-330-141-9005	1		Stützradverstellung					
10	HO-020-082z	1		Sechskantschraube	Vis à six pans	Hexagon bolt	Vite esagonale	Sekskantskrue	M8x16
11	AD-210-143-9005	1		Bowdenzughalter	Serre câble	Cable support	Supporto cavo	Wireholder	
12	HO-020-083z	2		Sechskantschraube	Vis à six pans	Hexagon bolt	Vite esagonale	Sekskantskrue	M8x20
13	KC-001-074	1		Spez.-Scheibe	Rondelle	Washer	Rondella	Skive	B13
(14)	HI-020-008	1		Druckfeder	Ressort de pression	Compression spring	Molla di compressione	Fjær	
15	HR-010-005z	3		Sechskantmutter	écrou à six pans	Hexagon nut	Dado esagonale	Sekskantmutter	M8x16
16	HJ-010-143	1		Kabelbinder	Collier en plastique	Cable strap	Cinghia di cavo		
(17)	HK-005-023	1		Faltenbalg	Caoutchouc de protection	Protection rubber	Gomma protezione	Gummi	
18	AD-320-140z	1		Radträger	Support de roue	(wheel) carrier	Supporto ruota	Hjulholder	
(19)	AD-320-050TS	1		Rad kpl.	Roue cpl.	Wheel cpl.	Ruota completo	Hjul kpl.	
20	DC-181-048z	1		Hülse	Douille	Spacer tube	Boccola	Hylse	
21	HO-010-126z	1		Sechskantschraube	Vis à six pans	Hexagon bolt	Vite esagonale	Sekskantskrue	M10x90
22	HR-010-006z	1		Sechskantmutter	écrou à six pans	Hexagon nut	Dado esagonale	Sekskantmutter	M10
23	AD-210-147z	1		Spanner	Tendeur	Tensioner	Tenditore	Strammer	
(24)	HJ-021-011	1		Bundbuchse	Coussinet	Collar bush	Bussola flangiata	Foring	
25	HO-010-122z	1		Sechskantschraube	Vis à six pans	Hexagon bolt	Vite esagonale	Sekskantskrue	M10x65
26	DC-131-029z	1		Abstandshülse	Douille d'écartement	Spacer tube	Boccola distanziale	Avstandshylse	
(27)	AZ-002-005	1		Spannrolle	Galet tendeur	Tensioning pulley	Rullo tenditore	Strammerull	
28	HW-010-009z	1		Scheibe	Rondelle	Washer	Rondella	Skive	B10,5
29	HW-050-009z	3		Scheibe	Rondelle	Washer	Rondella	Skive	B10,5
30	HR-030-006z	1		Sicherungsmutter	écrou de sûreté	Locknut	Dado autobloccante	Låsemutter	M10
31	HO-020-115z	1		Sechskantschraube	Vis à six pans	Hexagon bolt	Vite esagonale	Sekskantskrue	M10x30
32	HR-010-006z	1		Sechskantmutter	écrou à six pans	Hexagon nut	Dado esagonale	Sekskantmutter	M10

weiter auf folgender Seite



Pos.-Nr.	Bestellnummer	Anzahl	Désignation	Description	Descrizione	Benevnelse	Bemerkung	
Rep.	Référence	Qté.						
Pos.	Article number	Quant.						
Pos.	Nr. codice	Q.tà						
Bilde-Nr.	Bestillings-Nr.	Antall						
(33)	AZ-002-001	1	Spannrolle	Galet tendeur	Tensioning pulley	Rullo tenditore	Strammerull	
(34)	AZ-007-081	1	Kupplungszug	Commande bowden	Clutch-cable	Cavo frizione	Clutchwire	
35	AD-210-144-9005	1	Keilriemenschutz	Carter de protection	V-belt cover	Protezione cinghia	Kileremsdeksel	
36	AD-210-145-9005	1	Motorkonsole	Embase moteur	Engine plate	Mensola motore	Motorfeste	
37	HP-056-083z	3	Flachrundschrabe	Vis à tête bombée	Cut head bolt	Vite testa tonda	Flatrundskrue	M 8x20
38	HW-010-007z	3	Scheibe	Rondelle	Washer	Rondella	Skive	B 8,4
39	HR-010-005z	3	Sechskantmutter	écrou à six pans	Hexagon nut	Dado esagonale	Sekskantmutter	M 8
40	HO-010-090z	2	Sechskantschraube	Vis à six pans	Hexagon bolt	Vite esagonale	Sekskantskrue	M 8x55
41	HO-010-095z	1	Sechskantschraube	Vis à six pans	Hexagon bolt	Vite esagonale	Sekskantskrue	M 8x80
42	HW-050-007z	3	Scheibe	Rondelle	Washer	Rondella	Skive	Ø 8,4
43	DC-181-092z	3	Hülse	Douille	Spacer tube	Boccola	Hylse	
44	DC-080-096z	1	Gewindebolzen	Goujon	Threaded pin	Perno filettato	Gjengebolt	
(45)	HJ-010-207	1	Sterngriff	Molette	Star grip	Pomello stella	Handtak	M 10
46	HP-056-083z	1	Flachrundschrabe	Vis à tête bombée	Cut head bolt	Vite testa tonda	Flatrundskrue	M 8x20
47a	HJ-210-224-9005	1	Keilriemenschutz	Carter de protection	V-belt cover	Protezione cinghia	Kileremsdeksel	Kawasaki
47b	HJ-210-225-9005	1	Keilriemenschutz	Carter de protection	V-belt cover	Protezione cinghia	Kileremsdeksel	Honda
47c	HJ-210-226-9005	1	Keilriemenschutz	Carter de protection	V-belt cover	Protezione cinghia	Kileremsdeksel	B&S
(48)	DX-001-102e	1	Keilriemenscheibe	Poulie	V-belt pulley	Puleggia	Kileremskive	
49	HP-022-049	2	Gewindestift	Cheville	Slotted set screw	Spina filettata	Gjengestift	M 6x6
(50)	HI-010-003	1	Zugfeder	Ressort de traction	Extension spring	Molla di trazione	Fjær	



Pos.-Nr. Rep. Pos. Pos. Bilde-Nr.	Bestellnummer Référence Article number Nr. codice Bestillings-Nr.	Anzahl Qté. Quant. Q.tà Antall		Désignation 	Description 	Descrizione 	Benevnelse 	Bemerkung	
1	AN-085-141-9005	1		Hebel	Levier	Lever	Leva	Hendel	
2	DN-090-039-9005	1		Bedienhebel	Levier de commande	Activating lever	Leva	Hendel	
3	HJ-010-013	1		Griff	Poignée	Handle	Leva	Handtak	
4	AZ-008-008z	1		Klappsplint	Goupille	Hinged pin	Spina sicurezza	Orepinne	
(5)	AZ-006-109	1		Gashebel	Accélérateur	Throttle lever	Leva gas	Gasshendel	(Kawasaki, Honda)
(5a)	AZ-006-094	1		Gashebel	Accélérateur	Throttle lever	Leva gas	Gasshendel	(B&S)
6	HO-010-062z	1		Sechskantschraube	Vis à six pans	Hexagon bolt	Vite esagonale	Sekskantskrue	(Kawasaki, Honda) M6x55
6a	HO-010-062z	2		Sechskantschraube	Vis à six pans	Hexagon bolt	Vite esagonale	Sekskantskrue	(B&S) M6x56
7	HW-010-004z	1		Scheibe	Rondelle	Washer	Rondella	Skive	(Kawasaki, Honda) B 6,4
7a	HW-010-004z	2		Scheibe	Rondelle	Washer	Rondella	Skive	(B&S) B 6,5
8	HR-030-004z	1		Sicherungsmutter	écrou de sûreté	Locknut	Dado autobloccante	Låsemutter	(Kawasaki, Honda) M6
8a	HR-030-004z	2		Sicherungsmutter	écrou de sûreté	Locknut	Dado autobloccante	Låsemutter	(B&S) M6
(9)	KA-079-001	1		Motor	Moteur	Motor	Motore	Motor	(Kawasaki)
(9a)	KA-076-001	1		Motor	Moteur	Motor	Motore	Motor	(Honda)
(9b)	KA-075-001	1		Motor	Moteur	Motor	Motore	Motor	(B&S)